

SD Series

Zero Backlash Disk Coupling



DISK COUPLING of SI is built-in coupling which provides big torsion rigidity and superior mobility, and it is high precision coupling that has nearly permanent lifespan.

DISK COUPLING of SI can rotate with high speed in one or two directions and is often used mainly in high-precision measuring equipments, high speed movement control system, critical weight, dynamometer, precision encoder and so forth.

Features

- Designed with high torsion rigidity
- Not affected by backlash and has semi permanent lifespan
- Accept amplitude, eccentricity and misalignment between shafts
- Single-stage and double-stage types
- Built-in metal structure
- Low inertia
- High-precision position controlling system
- Identical regular and reverse rotational characteristics
- Maintenance free and excellent resistance against oil

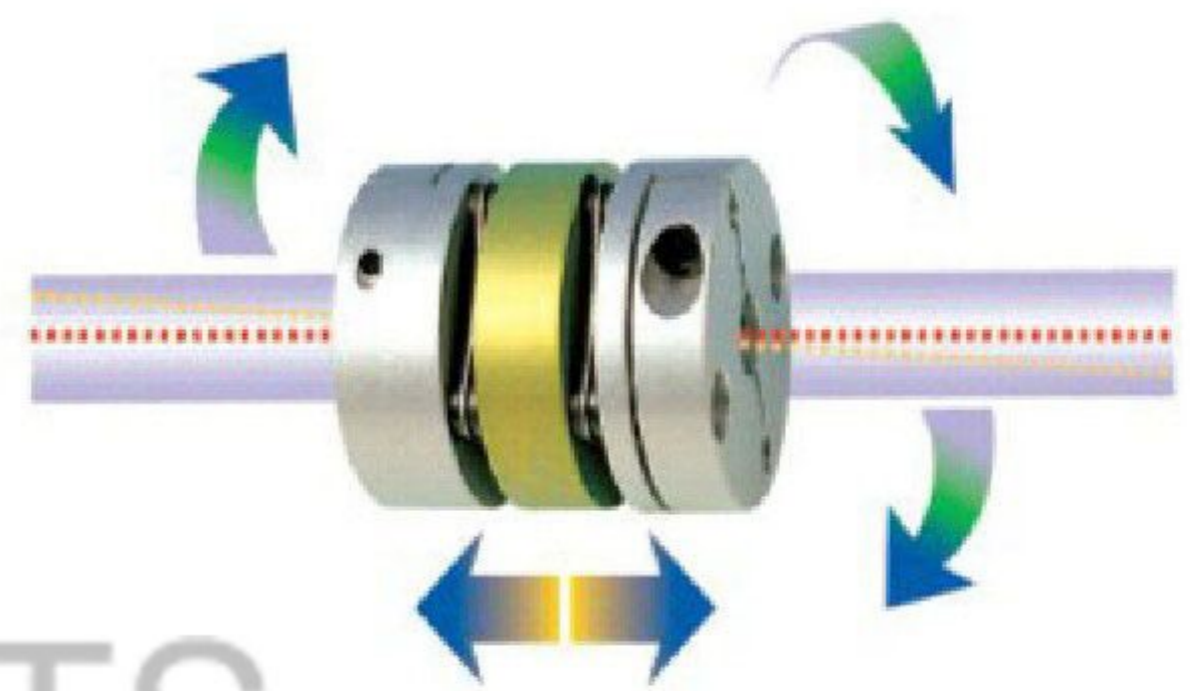

Misalignment

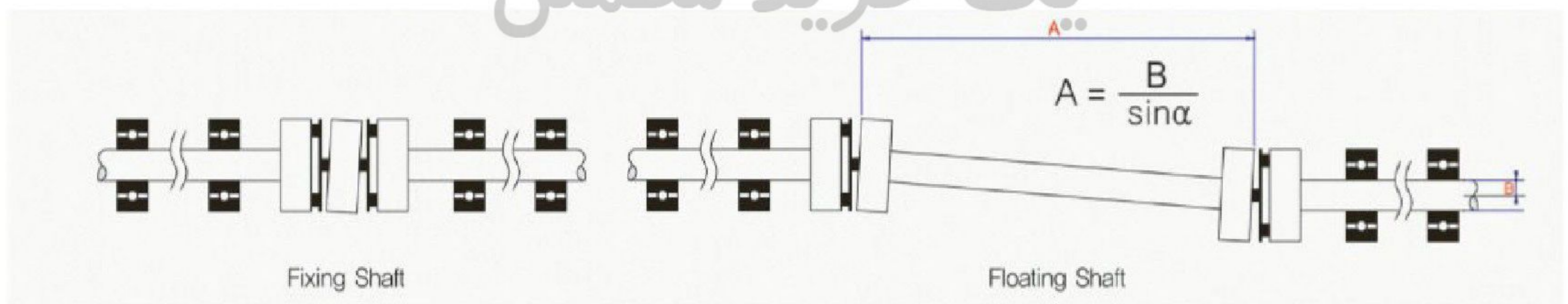
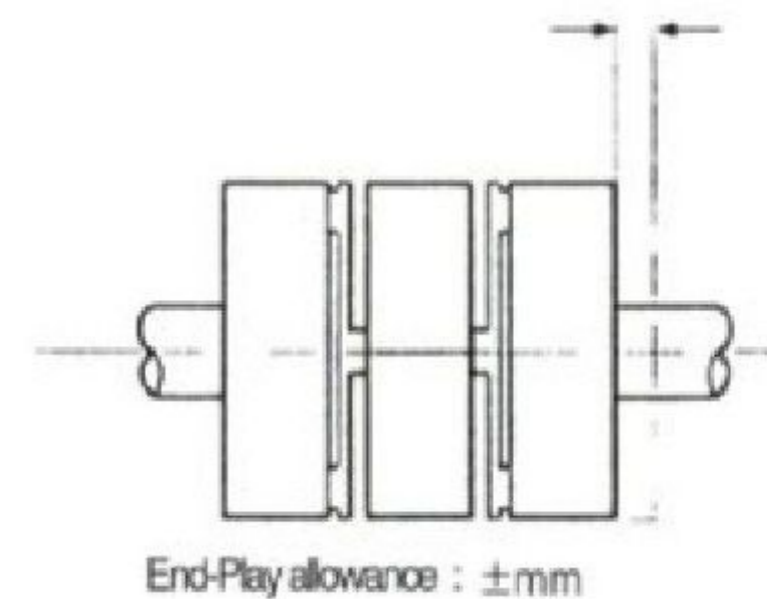
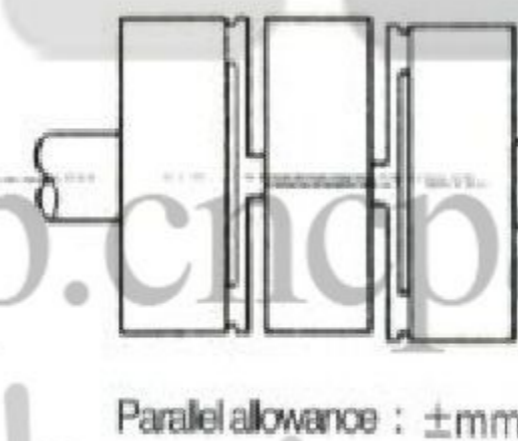
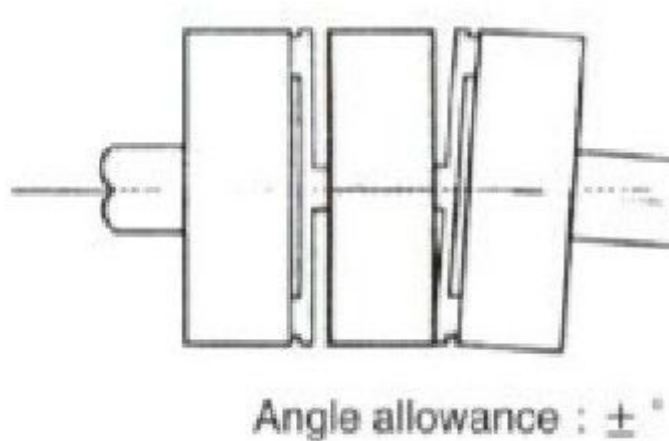

Application

- Servo motor, stepping motor, precision motor and so forth
- High precision encoder and dynamometer drive
- High speed and high precision position controlling system, centrifugal separator
- Copy machine, information, communication and audio equipment

How to order product

SDW□ – 31C

$\phi 6$

×

$\phi 8$

Product No.

Shaft Dia

Shaft Dia

※ Please, specify the diameters of both shaft ends in the order form.

تهران، خیابان سعدی جنوبی، چهارراه اکباتان کوچه ناظم الاطبا شمالی، ابتدای کوچه، پلاک ۱۶۷
 ۳۶۶۱۹۳۹۰ - ۳۶۶۱۹۵۱۰ - ۳۳۵۳۲۱۹۴ - ۳۳۹۵۹۰۳۴ - ۳۳۹۵۹۷۵۶ - ۳۳۹۵۹۳۲۶

SD Series Zero Backlash Disk Coupling

* Please, download CAD DATA on www.sungilfa.com

SDW-■-■-■ (SET SCREW TYPE) SDA-■-■-■ (SET SCREW TYPE) SDW-■-■-■C (CLAMP TYPE) SDA-■-■-■C (CLAMP TYPE)

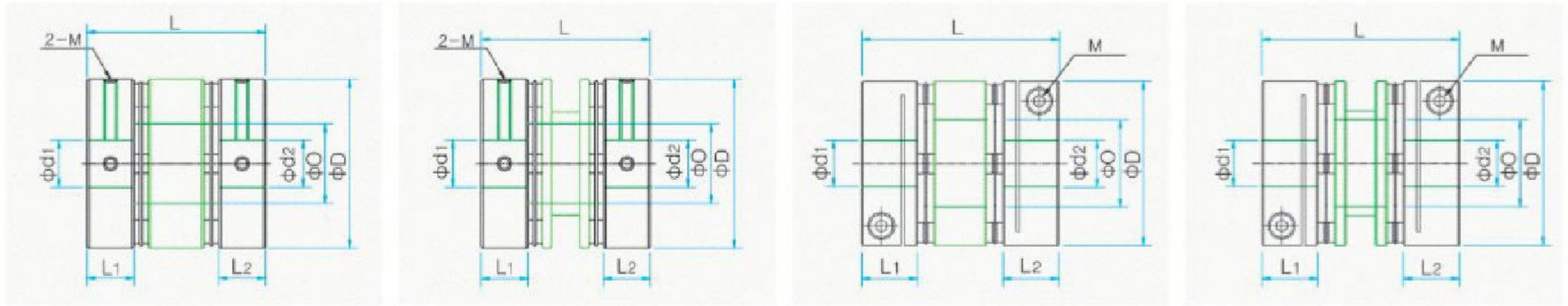

Standards & Performance

Product Number	DIMENSION(mm)(±0.3)					mass (g)	Rated Torque (N·m)	Max Torque (N·m)	Torsional Stiffness (N·m/rad)	Max·RPM (min ⁻¹)	Moment of inertia (kg·m ²)	Errors of Misalignment		
	φ D	L1 L2	L	M	O							Angle(°)	Parallel(mm)	End-Play(mm)
SDWA-16	16	5.1	15.6	2.5	6.2	6	0.5	1	200	12,000	2.2 × 10 ⁻⁷	3	0.2	0.2
SDWB-16	16	5.1	17.6	2.5	6.2	7	0.5	1	200	12,000	2.6 × 10 ⁻⁷	3	0.2	0.2
SDWA-16C	16	7.8	21	2	6.2	9	0.5	1	200	10,000	3.3 × 10 ⁻⁷	3	0.2	0.2
SDWB-16C	16	7.8	23	2	6.2	10	0.5	1	200	10,000	3.7 × 10 ⁻⁷	3	0.2	0.2
SDWA-19	19	6.1	18	3	8.2	10	0.9	1.8	300	12,000	5.3 × 10 ⁻⁷	3	0.2	0.2
SDWB-19	19	6.1	21	3	8.2	11	0.9	1.8	300	12,000	5.8 × 10 ⁻⁷	3	0.2	0.2
SDWA-19C	19	8.7	23	2.6	8.2	14	0.9	1.8	300	10,000	7.4 × 10 ⁻⁷	3	0.2	0.2
SDWB-19C	19	8.7	26.2	2.6	8.2	15	0.9	1.8	300	10,000	7.9 × 10 ⁻⁷	3	0.2	0.2
SDWA-22	22.2	6.2	20	3	9	16	1.1	2.2	400	12,000	1.0 × 10 ⁻⁶	3	0.2	0.2
SDWB-22	22.2	6.2	22.2	3	9	17	1.1	2.2	400	12,000	1.1 × 10 ⁻⁶	3	0.3	0.2
SDA-22	22.2	6.2	28.2	3	8.3	18	1.1	2.2	400	12,000	1.3 × 10 ⁻⁶	3	0.4	0.2
SDWA-22C	22.2	8.7	25	2.6	9	18	1.1	2.2	400	10,000	1.3 × 10 ⁻⁶	3	0.2	0.2
SDWB-22C	22.2	8.7	27	2.6	9	19	1.1	2.2	400	10,000	1.4 × 10 ⁻⁶	3	0.3	0.2
SDA-22C	22.2	8.7	33	2.6	8.3	20	1.1	2.2	400	10,000	1.5 × 10 ⁻⁶	3	0.4	0.2

☑ Please check beside figure that is the length of single type

SDS 16 = 11.9 SDS 19 = 14 SDS 22 = 14.7
 SDS 16C = 17.4 SDS 19C = 19.2 SDS 22C = 19.6

Standard Inner diameter

Product Number	(d ₁ , d ₂) Standard INNER Diameter (mm)									
	2	3	4	4.5	5	6	7	8	9	10
SDWA-16		●	●	●	●					
SDWA-16C		●	●	●	●					
SDWA-19		●	●	●	●	●				
SDWA-19C		●	●	●	●	●				
SDWA-22		●	●	●	●	●	●	●	●★	●★
SDWA-22C		●	●	●	●	●	●	●	●★	●★

☑ INNER diameter INCH type is also available.

☑ Non standard inner diameter product is also available

☑ KEY TYPE is also available

☑ The inner diameter that is marked ★ is not available by shaft through type



* Hub design can be changed according to diameter size

تهران، خیابان سعدی جنوبی، چهارراه اکباتان کوچه ناظم الاطبا شمالی، ابتدای کوچه، پلاک ۱۶۷
 ۳۶۶۱۹۳۹۰ - ۳۶۶۱۹۵۱۰ - ۳۳۵۳۲۱۹۴ - ۳۳۹۵۹۰۳۴ - ۳۳۹۵۹۷۵۶ - ۳۳۹۵۹۳۲۶

SD Series Zero Backlash Disk Coupling

SDW - ■■■ (SET SCREW TYPE)
 SDA - ■■■ (SET SCREW TYPE)
 SDW - ■■■ C (CLAMP TYPE)
 SDA - ■■■ C (CLAMP TYPE)
 SDWB(C) - 54C (CLAMP TYPE)

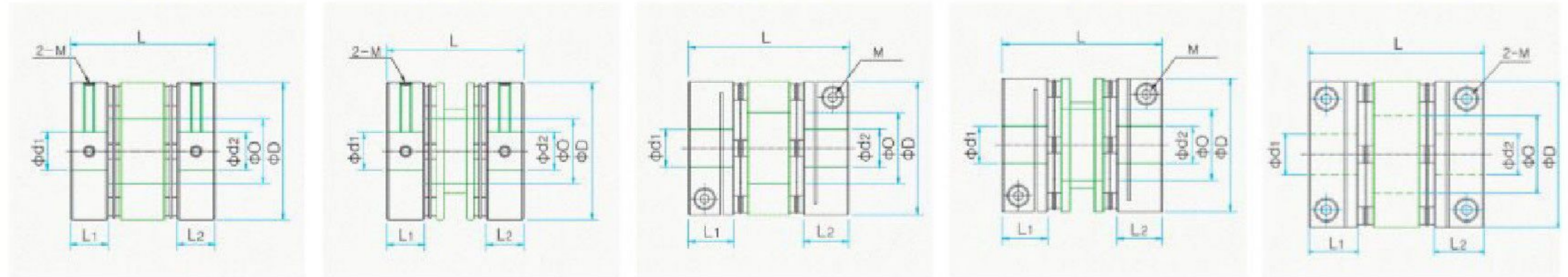

Standards & Performance

Product Number	DIMENSION(mm)(±0.3)					mass (g)	Rated Torque (N·m)	Max Torque (N·m)	Torsional Stiffness (N·m/rad)	Max·RPM (min ⁻¹)	Moment of inertia (kg·m ²)	Errors of Misalignment		
	φ D	L1 L2	L	M	O							Angle(°)	Parallel(mm)	End-Play(mm)
SDWA-26	26.6	7.3	26	4	12.2	28	1.5	3.0	600	10,000	2.3 × 10 ⁻⁶	3	0.3	0.3
SDA-26	26.6	7.3	31.5	4	10.5	32	1.5	3.0	600	10,000	3.2 × 10 ⁻⁶	3	0.4	0.3
SDWA-26C	26.6	10.7	32.6	3	12.2	34	1.5	3.0	600	9,000	3.4 × 10 ⁻⁶	3	0.3	0.3
SDA-26C	26.6	10.7	38.5	3	10.5	39	1.5	3.0	600	9,000	3.9 × 10 ⁻⁶	3	0.4	0.3
SDWA-31	31.8	7.2	24.5	4	14.5	30	3.0	6.0	1,300	9,000	4.3 × 10 ⁻⁶	3	0.2	0.4
SDWB-31	31.8	7.2	29.5	4	14.5	38	3.0	6.0	1,300	9,000	5.5 × 10 ⁻⁶	3	0.3	0.4
SDA-31	31.8	7.2	36	4	12.5	38	3.0	6.0	1,300	9,000	5.5 × 10 ⁻⁶	3	0.4	0.4
SDWA-31C	31.8	11.6	33.5	3	14.5	52	3.0	6.0	1,300	8,500	7.5 × 10 ⁻⁶	3	0.2	0.4
SDWB-31C	31.8	11.6	38.5	3	14.5	60	3.0	6.0	1,300	8,500	8.8 × 10 ⁻⁶	3	0.3	0.4
SDA-31C	31.8	11.6	44.7	3	12.5	60	3.0	6.0	1,300	8,500	8.8 × 10 ⁻⁶	3	0.4	0.4
SDWA-39C	39	13.6	39	4	17	95	5	10	1,800	8,000	2.1 × 10 ⁻⁵	3	0.2	0.4
SDWC-39C	39	13.6	44.8	4	17	110	5	10	1,800	8,000	2.4 × 10 ⁻⁵	3	0.3	0.4
SDA-39C	39	13.6	56.2	4	17	120	5	10	1,800	8,000	3.0 × 10 ⁻⁵	3	0.4	0.4
SDWC-42C	42.5	13.6	46	4	18	120	6	12	2,000	8,000	3.3 × 10 ⁻⁵	3	0.3	0.5
SDWC-47C	47	16	50	4	20.4	160	10	20	4,000	7,000	5.5 × 10 ⁻⁵	3	0.4	0.5
SDWB-54C	54	19	52	5	25	250	22	44	7,000	6,000	1.1 × 10 ⁻⁴	3	0.3	0.5
SDWC-54C	54	19	58	5	25	280	22	44	7,000	6,000	1.2 × 10 ⁻⁴	3	0.4	0.5

▶ Please check beside figure that is the length of single type
 SDS 26 = 17.5 SDS 31 = 17.7
 SDS 39C = 31 SDS 26C = 24.1 SDS 31C = 26.5

Standard Inner diameter

Product Number	(d ₁ , d ₂) Standard INNER Diameter (mm)													
	4	5	6	6.35	7	8	9	9.525	10	11	12	12.7	14	15
SDWA-26	•	•	•	•	•	•	•	•	•					
SDWA-26C	•	•	•	•	•	•	•	•	•					
SDWA-31				•	•	•	•	•	•	•	•	•	•	•★
SDWA-31C				•	•	•	•	•	•	•	•	•	•	•★

Product Number	(d ₁ , d ₂) Standard INNER Diameter (mm)																						
	4	4.5	5	6	6.35	7	8	9	9.525	10	11	12	12.7	14	15	15.875	16	17	18	19	20	24	25
SDWA-39C			•	•	•	•	•	•	•	•	•	•	•	•	•	•							
SDWC-42C				•	•	•	•	•	•	•	•	•	•	•	•	•	•	•	•★	•★			
SDWC-47C							•	•	•	•	•	•	•	•	•	•	•	•	•	•	•	•	•
SDWC-54C									•	•	•	•	•	•	•	•	•	•	•	•	•	•	•

▶ INNER diameter INCH type is also available. ▶ Non standard inner diameter product is also available
 ▶ KEY TYPE is also available ▶ The inner diameter that is marked ★ is not available by shaft through type

SD Series Zero Backlash Disk Coupling

※ Please, download CAD DATA on www.sungilfa.com

○ SDS - ■ ■ (SET SCREW TYPE)

○ SDW ■ - ■ ■ (SET SCREW TYPE)

○ SDA ■ - ■ ■ (SET SCREW TYPE)

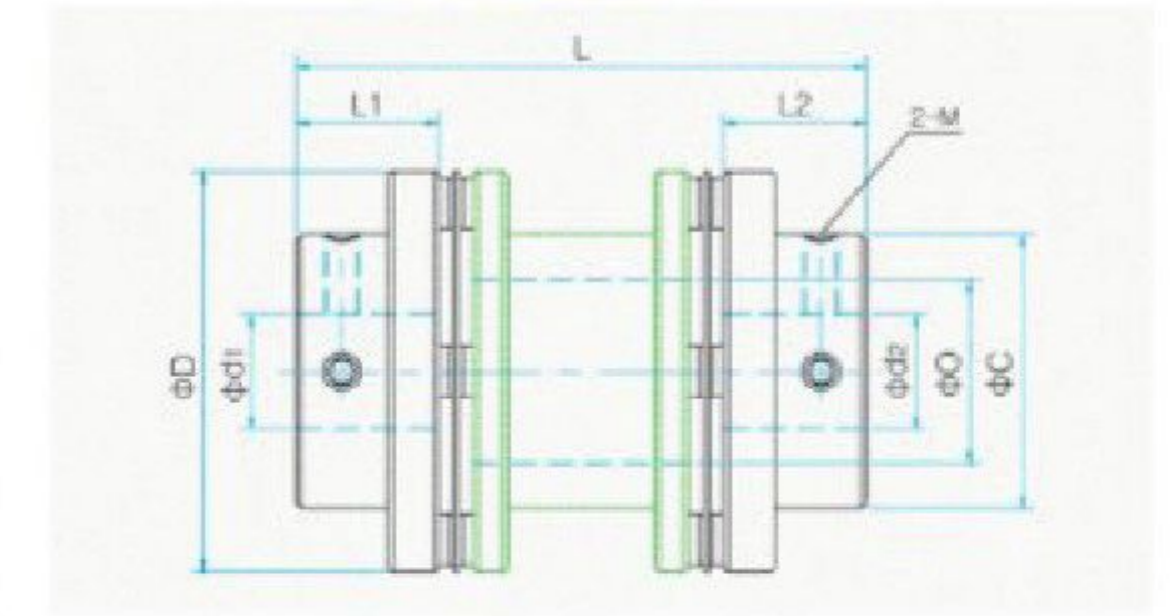
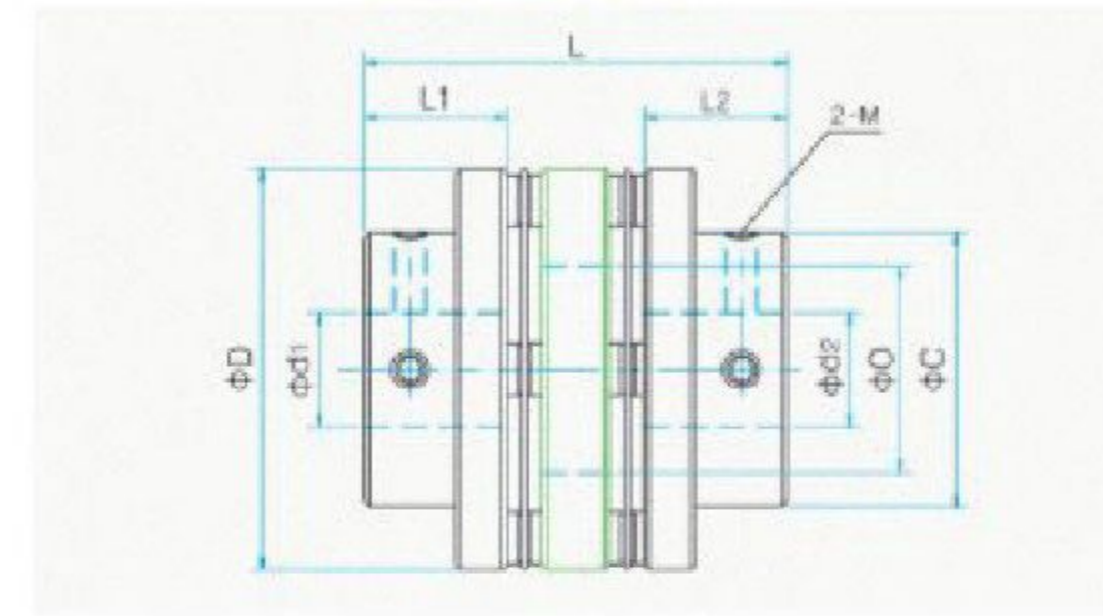
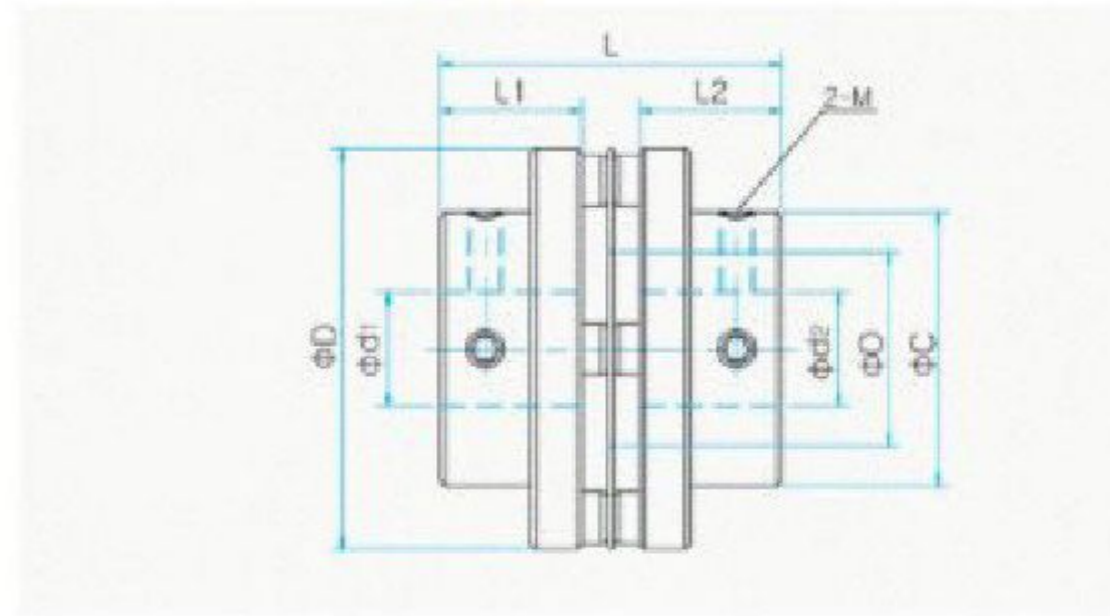

Standards & Performance

Product Number	DIMENSION(mm)(±0.3)						mass (g)	Rated Torque (N·m)	Max Torque (N·m)	Torsional Stiffness (N·m/rad)	Max·RPM (min ⁻¹)	Moment of inertia (kg·m ²)	Errors of Misalignment		
	φ D	φ C	L1 L2	L	M	O							Angle(°)	Parallel(mm)	End-Play(mm)
SDS-42	42.5	29.2	13.5	31	4	18	65	6	12	2,800	8,000	1.7 × 10 ⁻⁵	1.5	0	0.2
SDWA-42	42.5	29.2	13.5	39.7	4	18	84	6	12	2,000	8,000	2.1 × 10 ⁻⁵	3	0.2	0.5
SDWB-42	42.5	29.2	13.5	44.2	4	18	94	6	12	2,000	8,000	2.4 × 10 ⁻⁵	3	0.3	0.5
SDAA-42	42.5	29.2	13.5	50	4	18	105	6	12	2,000	8,000	2.7 × 10 ⁻⁵	3	0.4	0.5
SDAB-42	42.5	29.2	13.5	58	4	18	110	6	12	2,000	8,000	2.8 × 10 ⁻⁵	3	0.5	0.5
SDAC-42	42.5	29.2	13.5	67.2	4	18	115	6	12	2,000	8,000	2.9 × 10 ⁻⁵	3	0.6	0.5
SDS-47	47	33	14	31.7	5	20.4	91	10	20	6,000	8,000	2.7 × 10 ⁻⁵	1.5	0	0.2
SDWA-47	47	33	14	40	5	20.4	115	10	20	4,000	8,000	3.4 × 10 ⁻⁵	3	0.2	0.5
SDWB-47	47	33	14	46	5	20.4	120	10	20	4,000	8,000	3.6 × 10 ⁻⁵	3	0.4	0.5
SDAA-47	47	33	14	58.5	5	20	140	10	20	4,000	8,000	4.2 × 10 ⁻⁵	3	0.5	0.5
SDAB-47	47	33	14	85	5	20	160	10	20	4,000	8,000	4.7 × 10 ⁻⁵	3	0.8	0.5
SDS-54	54	38.5	19	42.2	5	25	130	22	44	11,000	7,500	4.9 × 10 ⁻⁵	1.5	0	0.2
SDWA-54	54	38.5	19	55.5	5	25	177	22	44	7,000	7,500	6.7 × 10 ⁻⁵	3	0.2	0.5
SDAA-54	54	38.5	19	71	5	24	230	22	44	7,000	7,500	9.0 × 10 ⁻⁵	3	0.5	0.5
SDAB-54	54	38.5	19	85	5	24	250	22	44	7,000	7,500	1.1 × 10 ⁻⁴	3	0.7	0.5
SDS-64	64	48	26	58	8	25.5	292	31	62	20,000	7,000	1.8 × 10 ⁻⁴	1.5	0	0.2
SDWA-64	64	48	26	74	8	25.5	373	31	62	11,000	7,000	2.2 × 10 ⁻⁴	3	0.3	0.5
SDA-64	64	48	26	89.5	8	25.5	450	31	62	11,000	7,000	2.7 × 10 ⁻⁴	3	0.5	0.5

Standard Inner diameter

Product Number	(d ₁ , d ₂) Standard INNER Diameter (mm)																										
	5	6	6.3 ⁵	7	8	9	9.5 ²⁵	10	11	12	12.7	14	15	15.875	16	18	19	20	21	22	24	25	26	28	30	35	
SDW-42		●	●	●	●	●	●	●	●	●	●	●	●														
SDW-42C		●	●	●	●	●	●	●	●	●	●	●	●														
SDW-47					●	●	●	●	●	●	●	●	●	●	●	●	●										
SDW-47C					●	●	●	●	●	●	●	●	●	●	●	●	●										
SDW-54								●	●	●	●	●	●	●	●	●	●	●									
SDW-54C								●	●	●	●	●	●	●	●	●	●	●									
SDW-64										●	●	●	●	●	●	●	●	●	●	●	●	●	●	●	●	●	●
SDW-64C										●	●	●	●	●	●	●	●	●	●	●	●	●	●	●	●	●	●

Product Number	(d ₁ , d ₂) Standard INNER Diameter (mm)															
	15	16	18	19	20	22	24	25	28	30	32	35	40	45	50	
SDS-80C	●	●	●	●	●	●	●	●	●	●	●	●				
SDW-80C	●	●	●	●	●	●	●	●	●	●	●	●				
SDS-90C					●	●	●	●	●	●	●	●	●			
SDW-90C					●	●	●	●	●	●	●	●	●	●		
SDS-100C					●	●	●	●	●	●	●	●	●	●	●	★
SDW-100C					●	●	●	●	●	●	●	●	●	●	●	★

INNER diameter INCH type is also available.

Non standard inner diameter product is also available

KEY TYPE is also available

The inner diameter that is marked ★ is not available by shaft through type

SD Series Zero Backlash Disk Coupling

※ Please, download CAD DATA on www.sungilfa.com

○ SDS - ■ ■ C (CLAMP TYPE)

○ SDW - ■ ■ C (CLAMP TYPE)

○ SDA - ■ ■ C (CLAMP TYPE)

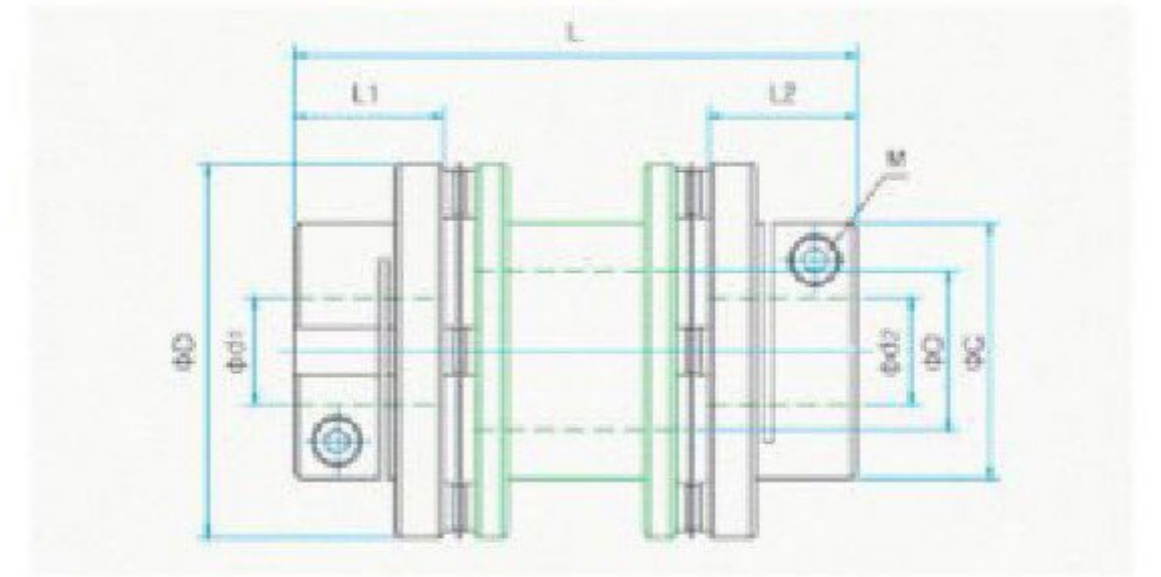
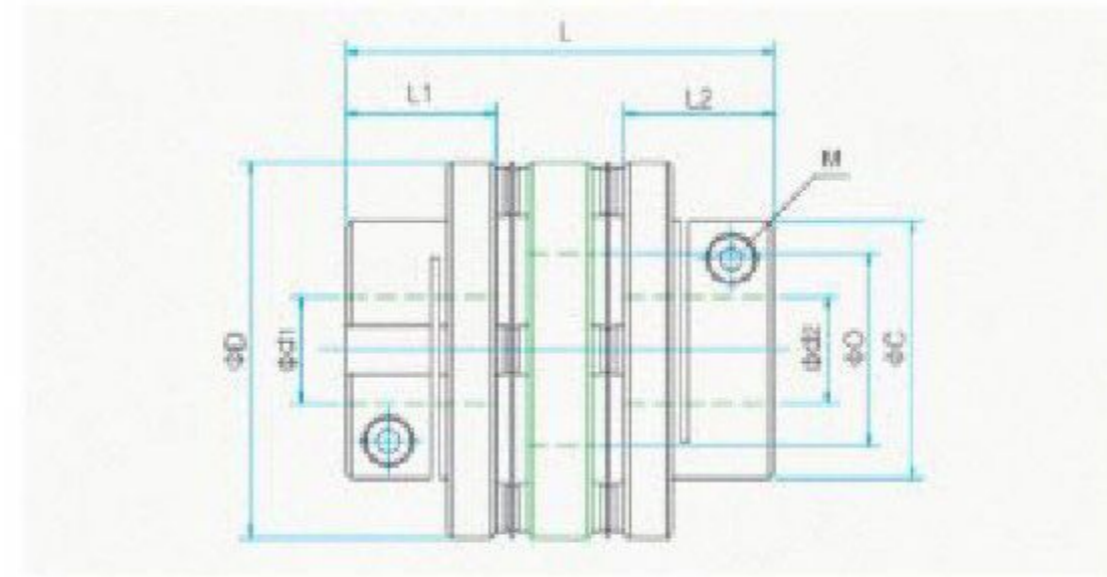
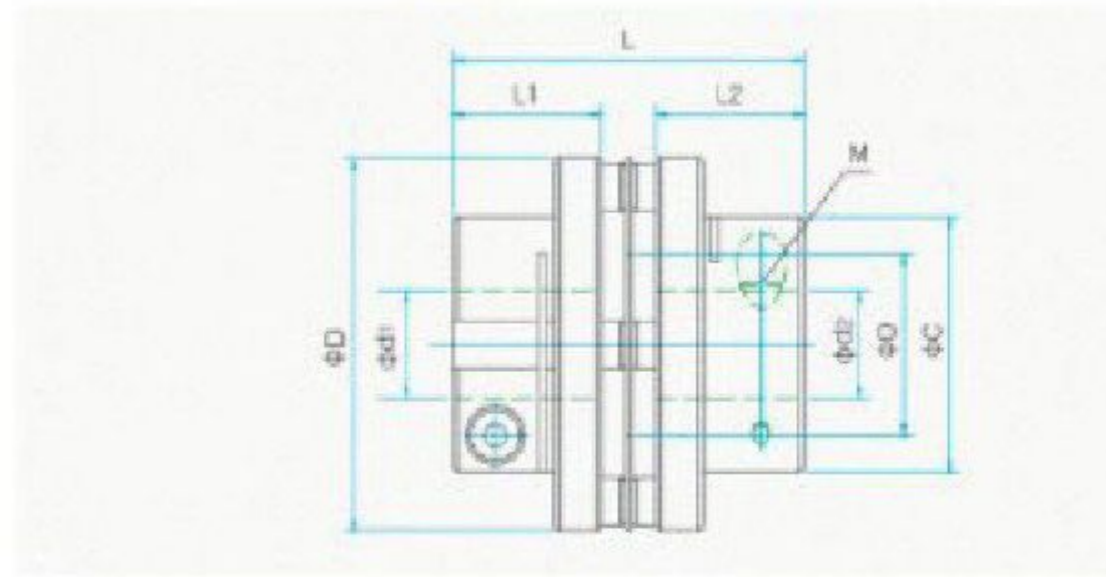

Standards & Performance

Product Number	DIMENSION(mm)(±0.3)						mass (g)	Rated Torque (N·m)	Max Torque (N·m)	Torsional Stiffness (N·m/rad)	Max·RPM (min ⁻¹)	Moment of inertia (kg·m ²)	Errors of Misalignment		
	ϕ D	ϕ C	L1 L2	L	M	O							Angle(°)	Parallel(mm)	End-Play(mm)
SDS-42C	42.5	29.2	13.5	31	3	18	65	6	12	2,800	8,000	1.7 × 10 ⁻⁵	1.5	0	0.2
SDWA-42C	42.5	29.2	13.5	39.7	3	18	84	6	12	2,000	8,000	2.1 × 10 ⁻⁵	3	0.2	0.5
SDWB-42C	42.5	29.2	13.5	44.2	3	18	94	6	12	2,000	8,000	2.4 × 10 ⁻⁵	3	0.3	0.5
SDAA-42C	42.5	29.2	13.5	50	3	18	105	6	12	2,000	8,000	2.7 × 10 ⁻⁵	3	0.4	0.5
SDAB-42C	42.5	29.2	13.5	58	3	18	110	6	12	2,000	8,000	2.8 × 10 ⁻⁵	3	0.5	0.5
SDAC-42C	42.5	29.2	13.5	67.2	3	18	115	6	12	2,000	8,000	2.9 × 10 ⁻⁵	3	0.6	0.5
SDS-47C	47	33	16.7	37	4	20.4	108	10	20	6,000	7,500	3.2 × 10 ⁻⁵	1.5	0	0.2
SDWA-47C	47	33	16.7	45.5	4	20.4	120	10	20	4,000	7,500	3.6 × 10 ⁻⁵	3	0.2	0.5
SDWB-47C	47	33	16.7	51.3	4	20.4	132	10	20	4,000	7,500	3.9 × 10 ⁻⁵	3	0.4	0.5
SDAA-47C	47	33	16.7	63.7	4	20	152	10	20	4,000	7,500	4.5 × 10 ⁻⁵	3	0.5	0.5
SDAB-47C	47	33	16.7	90.5	4	20	172	10	20	4,000	7,500	5.1 × 10 ⁻⁵	3	0.8	0.5
SDS-54C	54	38.5	21.5	47	5	25	145	22	44	11,000	7,000	5.5 × 10 ⁻⁵	1.5	0	0.2
SDWA-54C	54	38.5	21.5	60.5	5	25	192	22	44	7,000	7,000	7.2 × 10 ⁻⁵	3	0.2	0.5
SDAA-54C	54	38.5	21.5	75.6	5	24	240	22	44	7,000	7,000	9.0 × 10 ⁻⁵	3	0.5	0.5
SDAB-54C	54	38.5	21.5	89.5	5	24	266	22	44	7,000	7,000	1.1 × 10 ⁻⁴	3	0.7	0.5
SDS-64C	64	48	26	58	6	25.5	292	31	62	20,000	6,500	1.8 × 10 ⁻⁴	1.5	0	0.2
SDWA-64C	64	48	26	74	6	25.5	373	31	62	11,000	6,500	2.2 × 10 ⁻⁴	3	0.3	0.5
SDA-64C	64	48	26	89.5	6	25.5	450	31	62	11,000	6,500	2.7 × 10 ⁻⁴	3	0.5	0.5

○ SDS - ■ ■ C (CLAMP TYPE)

○ SDW - ■ ■ C (CLAMP TYPE)

○ SDA - ■ ■ C (CLAMP TYPE)

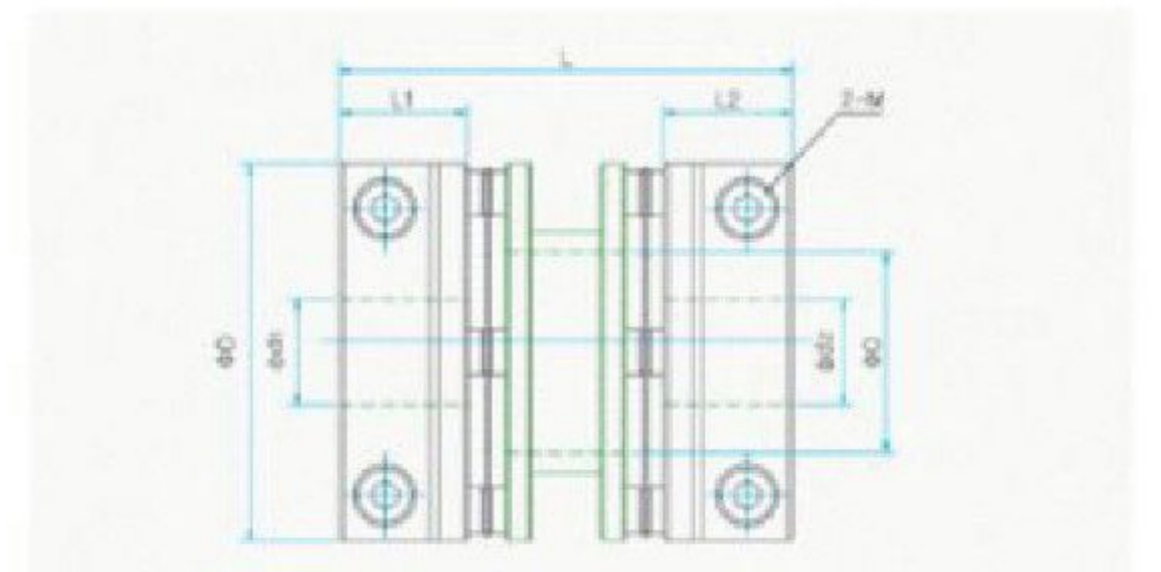
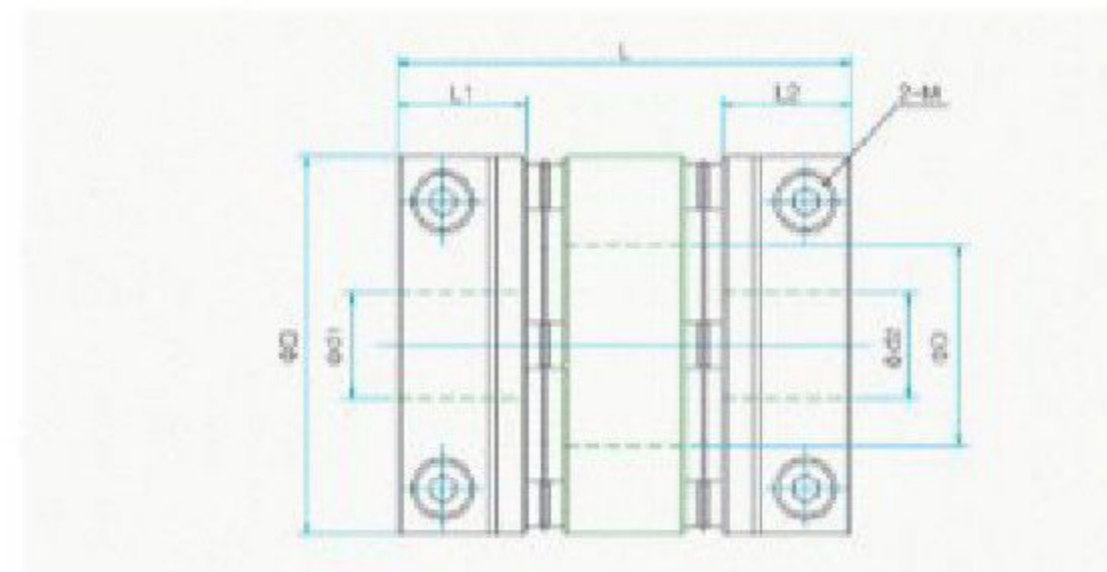
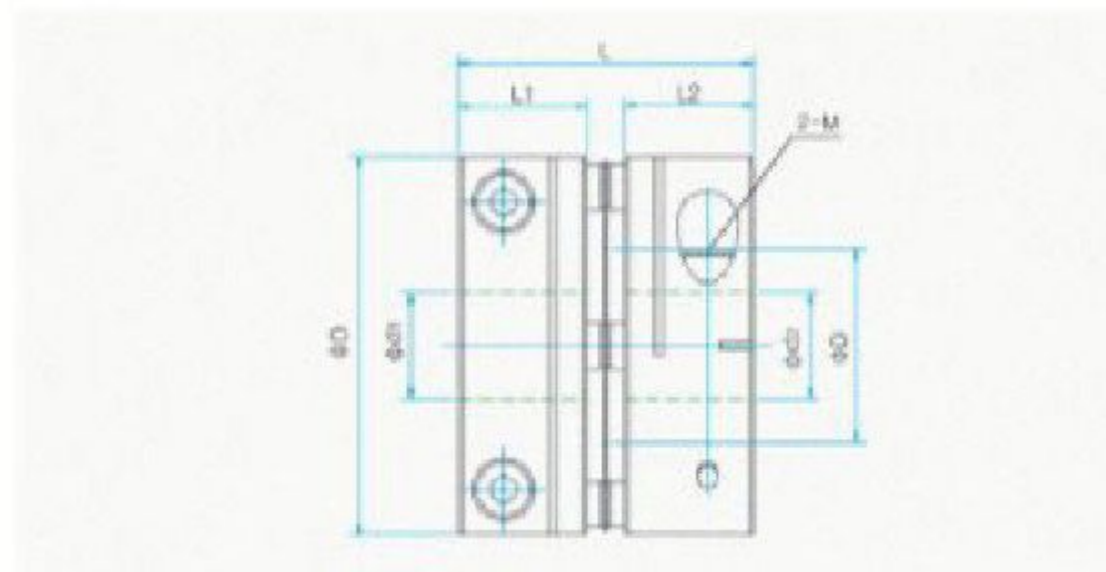

Standards & Performance

Product Number	DIMENSION(mm)(±0.3)					mass (g)	Rated Torque (N·m)	Max Torque (N·m)	Torsional Stiffness (N·m/rad)	Max·RPM (min ⁻¹)	Moment of inertia (kg·m ²)	Errors of Misalignment		
	ϕ D	L1 L2	L	M	O							Angle(°)	Parallel(mm)	End-Play(mm)
SDS-80C	80	30	66.8	8	35	800	75	150	32,000	6,000	7.5 × 10 ⁻⁴	2	0	0.3
SDW-80C	80	30	82.5	8	35	900	75	150	16,000	6,000	8.4 × 10 ⁻⁴	2	0.4	0.6
SDA-80C	80	30	98.5	8	32	1,000	75	150	16,000	6,000	9.5 × 10 ⁻⁴	2	0.5	0.6
SDS-90C	94.5	30.4	68.5	8	41.6	930	150	300	150,000	6,000	1.2 × 10 ⁻³	2	0	0.4
SDW-90C	94.5	30.4	98	8	41.6	1,350	150	300	70,000	6,000	1.8 × 10 ⁻³	2	0.4	0.8
SDS-100C	104.5	30.6	71	8	47	1,300	220	440	200,000	6,000	2.2 × 10 ⁻³	2	0	0.4
SDW-100C	104.5	30.6	102.5	8	47	1,700	220	440	100,000	6,000	2.9 × 10 ⁻³	2	0.4	0.8